



ALPHA & OMEGA
SEMICONDUCTOR, LTD

AO4435

P-Channel Enhancement Mode Field Effect Transistor



General Description

The AO4435/L uses advanced trench technology to provide excellent $R_{DS(ON)}$, and ultra-low low gate charge with a 25V gate rating. This device is suitable for use as a load switch or in PWM applications.
AO4435 and AO4435L are electrically identical.

- RoHS Compliant
- AO4435L is Halogen Free

Features

$V_{DS} = -30V$
 $I_D = -11A$ ($V_{GS} = -20V$)
 $R_{DS(ON)} < 14m\Omega$ ($V_{GS} = -20V$)
 $R_{DS(ON)} < 18m\Omega$ ($V_{GS} = -10V$)
 $R_{DS(ON)} < 36m\Omega$ ($V_{GS} = -5V$)

UIS TESTED!
 Rg, Ciss, Coss, Crss Tested

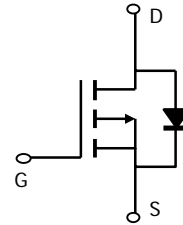
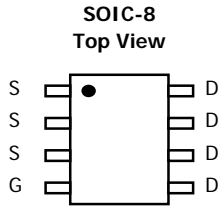

Absolute Maximum Ratings $T_A=25^\circ C$ unless otherwise noted

Parameter	Symbol	Maximum	Units
Drain-Source Voltage	V_{DS}	-30	V
Gate-Source Voltage	V_{GS}	± 25	V
Continuous Drain Current ^A	I_D	$T_A=25^\circ C$	-11
		$T_A=70^\circ C$	-8
Pulsed Drain Current ^B	I_{DM}	-80	A
Power Dissipation ^A	P_D	$T_A=25^\circ C$	3.1
		$T_A=70^\circ C$	2.0
Avalanche Current ^B	I_{AR}	-20	A
Repetitive avalanche energy 0.3mH ^B	E_{AR}	60	mJ
Junction and Storage Temperature Range	T_J, T_{STG}	-55 to 150	$^\circ C$

Thermal Characteristics

Parameter	Symbol	Typ	Max	Units
Maximum Junction-to-Ambient ^A	$R_{\theta JA}$	32	40	$^\circ C/W$
Maximum Junction-to-Ambient ^A		60	75	$^\circ C/W$
Maximum Junction-to-Lead ^C	$R_{\theta JL}$	17	24	$^\circ C/W$

Electrical Characteristics ($T_J=25^\circ\text{C}$ unless otherwise noted)

Symbol	Parameter	Conditions	Min	Typ	Max	Units
STATIC PARAMETERS						
BV_{DSS}	Drain-Source Breakdown Voltage	$I_D = -250\mu\text{A}, V_{GS} = 0\text{V}$	-30			V
I_{DSS}	Zero Gate Voltage Drain Current	$V_{DS} = -30\text{V}, V_{GS} = 0\text{V}$ $T_J = 55^\circ\text{C}$			-1 -5	μA
I_{GSS}	Gate-Body leakage current	$V_{DS} = 0\text{V}, V_{GS} = \pm 25\text{V}$			± 100	nA
$V_{GS(th)}$	Gate Threshold Voltage	$V_{DS} = V_{GS}, I_D = -250\mu\text{A}$	-1.7	-2.3	-3	V
$I_{D(ON)}$	On state drain current	$V_{GS} = -10\text{V}, V_{DS} = -5\text{V}$	-80			A
$R_{DS(ON)}$	Static Drain-Source On-Resistance	$V_{GS} = -20\text{V}, I_D = -11\text{A}$		11	14	m Ω
		$T_J = 125^\circ\text{C}$		15	19	
		$V_{GS} = -10\text{V}, I_D = -10\text{A}$		15	18	
		$V_{GS} = -5\text{V}, I_D = -5\text{A}$		27	36	
g_{FS}	Forward Transconductance	$V_{DS} = -5\text{V}, I_D = -10\text{A}$		22		S
V_{SD}	Diode Forward Voltage	$I_S = -1\text{A}, V_{GS} = 0\text{V}$		-0.74	-1	V
I_S	Maximum Body-Diode Continuous Current				-3.5	A
DYNAMIC PARAMETERS						
C_{iss}	Input Capacitance	$V_{GS}=0\text{V}, V_{DS}=-15\text{V}, f=1\text{MHz}$		1130	1400	pF
C_{oss}	Output Capacitance			240		pF
C_{riss}	Reverse Transfer Capacitance			155		pF
R_g	Gate resistance	$V_{GS}=0\text{V}, V_{DS}=0\text{V}, f=1\text{MHz}$		5.8	8	Ω
SWITCHING PARAMETERS						
$Q_{g(10V)}$	Total Gate Charge	$V_{GS}=-10\text{V}, V_{DS}=-15\text{V}, I_D=-10\text{A}$		18	24	nC
$Q_{g(4.5V)}$	Total Gate Charge			9.5		
Q_{gs}	Gate Source Charge			5.5		nC
Q_{gd}	Gate Drain Charge			3.3		nC
$t_{D(on)}$	Turn-On DelayTime			8.7		ns
t_r	Turn-On Rise Time	$V_{GS}=-10\text{V}, V_{DS}=-15\text{V}, R_L=1.5\Omega,$ $R_{GEN}=3\Omega$		8.5		ns
$t_{D(off)}$	Turn-Off DelayTime			18		ns
t_f	Turn-Off Fall Time			7		ns
t_{rr}	Body Diode Reverse Recovery Time	$I_F=-10\text{A}, di/dt=100\text{A}/\mu\text{s}$		25	30	ns
Q_{rr}	Body Diode Reverse Recovery Charge	$I_F=-10\text{A}, di/dt=100\text{A}/\mu\text{s}$		12		nC

A: The value of $R_{\theta JA}$ is measured with the device mounted on 1 in² FR-4 board with 2oz. Copper, in a still air environment with $T_A = 25^\circ\text{C}$. The value in any given application depends on the user's specific board design. The current rating is based on the $t \leq 10\text{s}$ thermal resistance rating.

B: Repetitive rating, pulse width limited by junction temperature.

C: The $R_{\theta JA}$ is the sum of the thermal impedance from junction to lead $R_{\theta JL}$ and lead to ambient.

D: The static characteristics in Figures 1 to 6 are obtained using $<300 \mu\text{s}$ pulses, duty cycle 0.5% max.

E: These tests are performed with the device mounted on 1 in² FR-4 board with 2oz. Copper, in a still air environment with $T_A=25^\circ\text{C}$. The SOA curve provides a single pulse rating.

F: The current rating is based on the $t \leq 10\text{s}$ thermal resistance rating.

G: E_{AR} and I_{AR} ratings are based on low frequency and duty cycles to keep $T_J=25^\circ\text{C}$.

Rev4: Sept 2008

THIS PRODUCT HAS BEEN DESIGNED AND QUALIFIED FOR THE CONSUMER MARKET. APPLICATIONS OR USES AS CRITICAL COMPONENTS IN LIFE SUPPORT DEVICES OR SYSTEMS ARE NOT AUTHORIZED. AOS DOES NOT ASSUME ANY LIABILITY ARISING OUT OF SUCH APPLICATIONS OR USES OF ITS PRODUCTS. AOS RESERVES THE RIGHT TO IMPROVE PRODUCT DESIGN, FUNCTIONS AND RELIABILITY WITHOUT NOTICE.

TYPICAL ELECTRICAL AND THERMAL CHARACTERISTICS

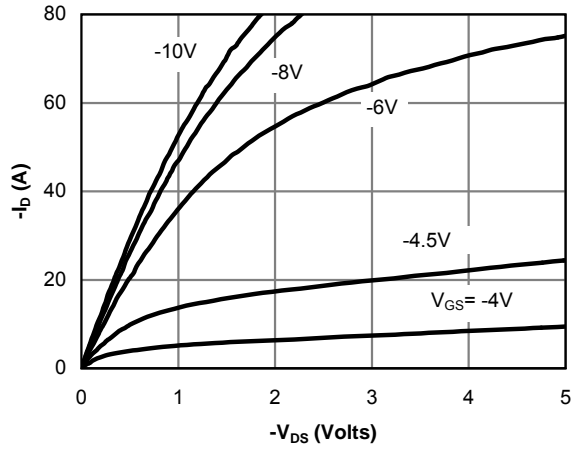

Figure 1: On-Region Characteristics

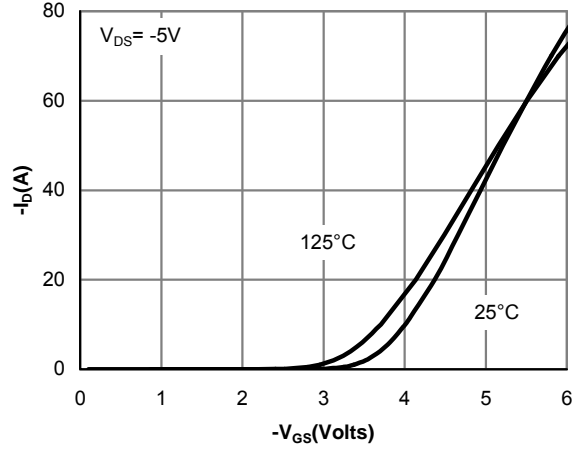

Figure 2: Transfer Characteristics

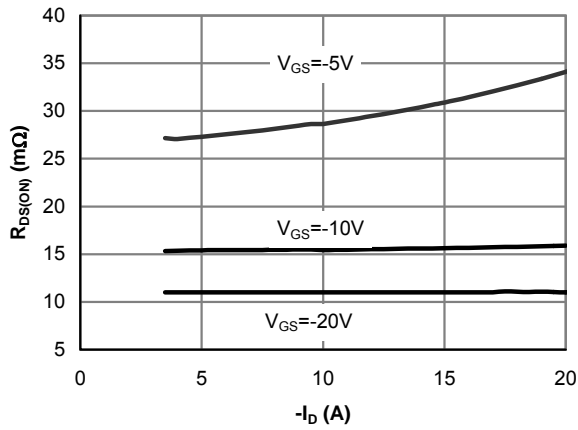

Figure 3: On-Resistance vs. Drain Current and Gate Voltage

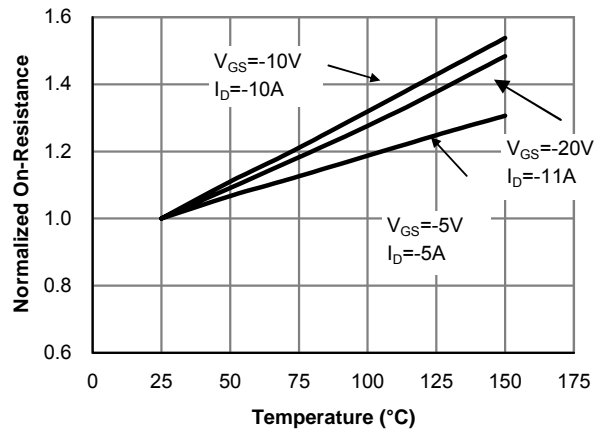

Figure 4: On-Resistance vs. Junction Temperature

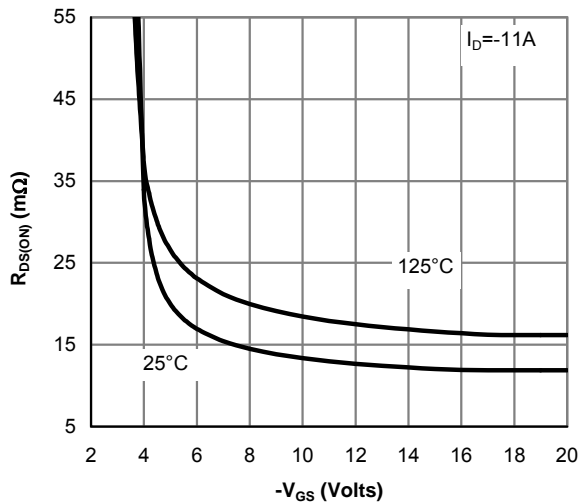

Figure 5: On-Resistance vs. Gate-Source Voltage

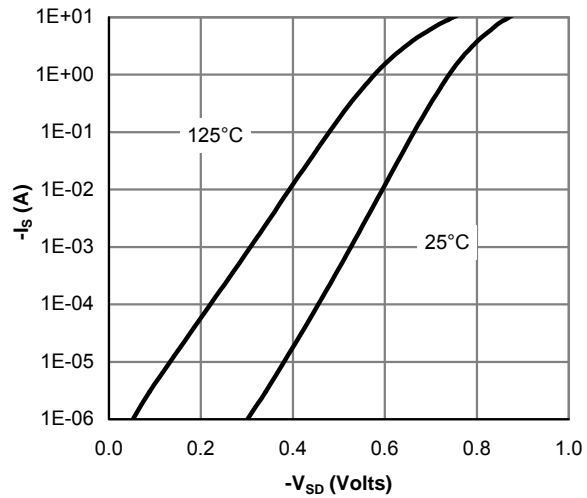

Figure 6: Body-Diode Characteristics

TYPICAL ELECTRICAL AND THERMAL CHARACTERISTICS

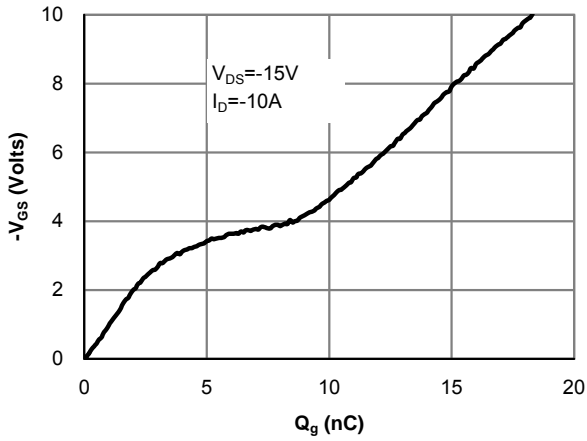

Figure 7: Gate-Charge Characteristics

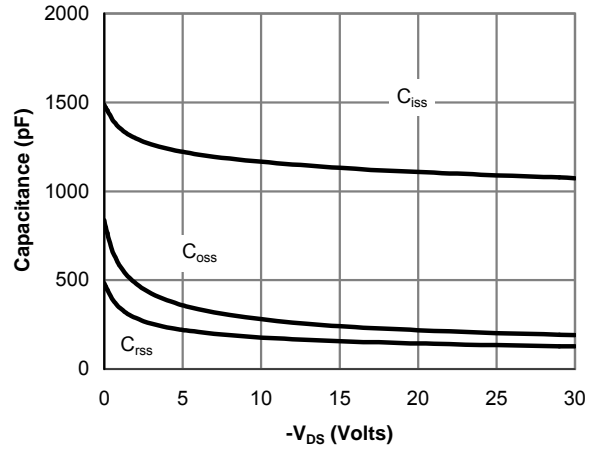

Figure 8: Capacitance Characteristics

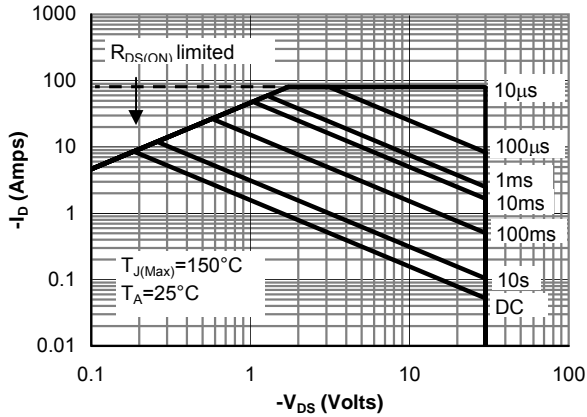

Figure 9: Maximum Forward Biased Safe Operating Area (Note E)

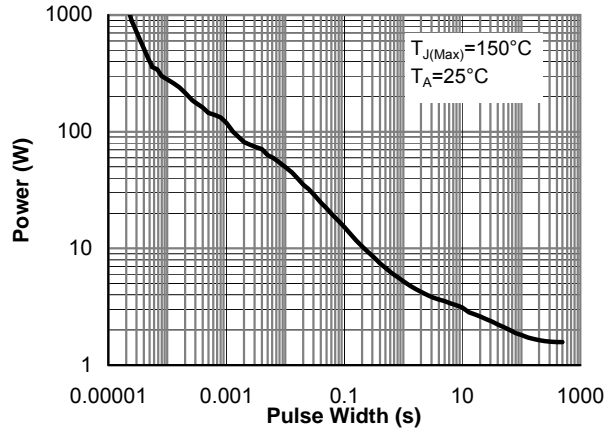

Figure 10: Single Pulse Power Rating Junction-to-Ambient (Note E)

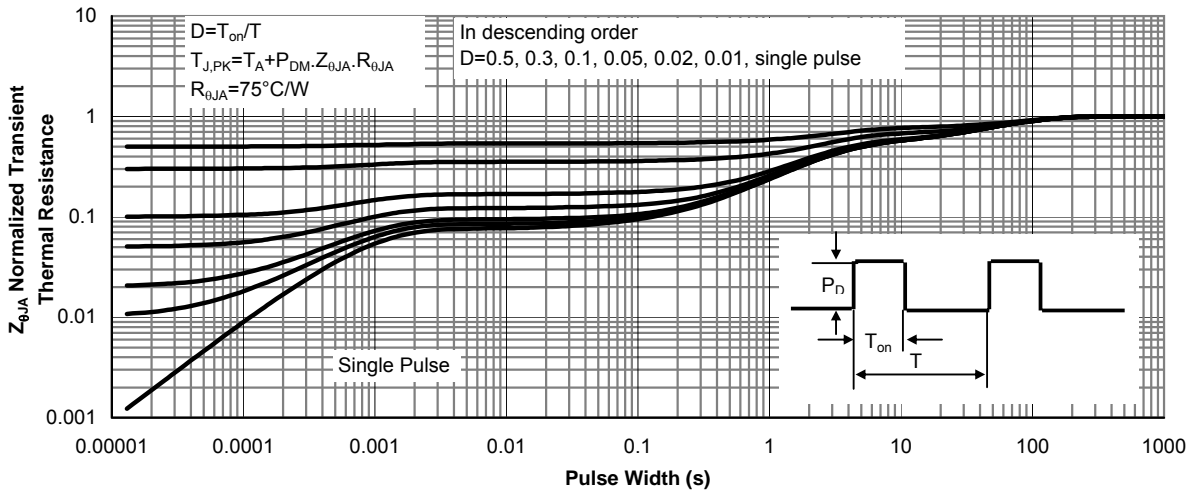
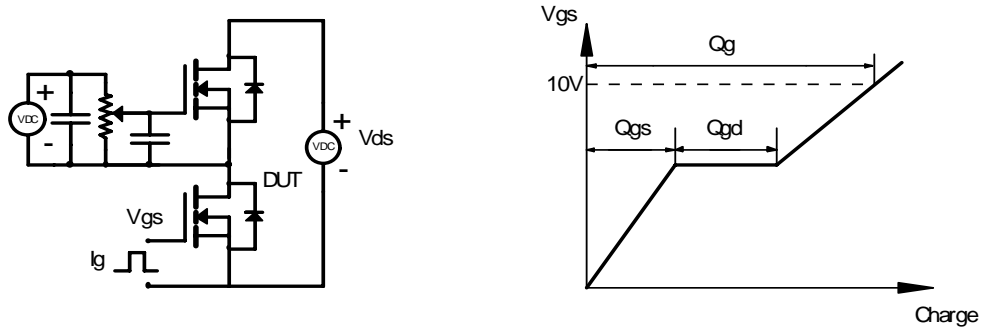
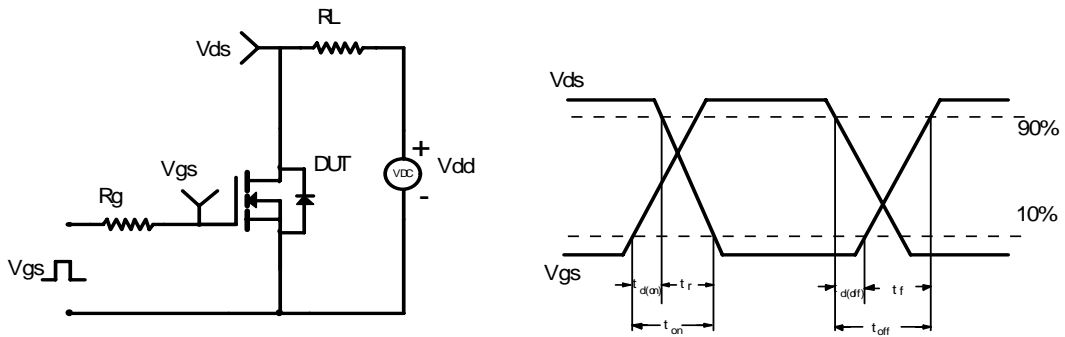

Figure 11: Normalized Maximum Transient Thermal Impedance (Note E)

Gate Charge Test Circuit & Waveform



Resistive Switching Test Circuit & Waveforms



Unclamped Inductive Switching (UIS) Test Circuit & Waveforms

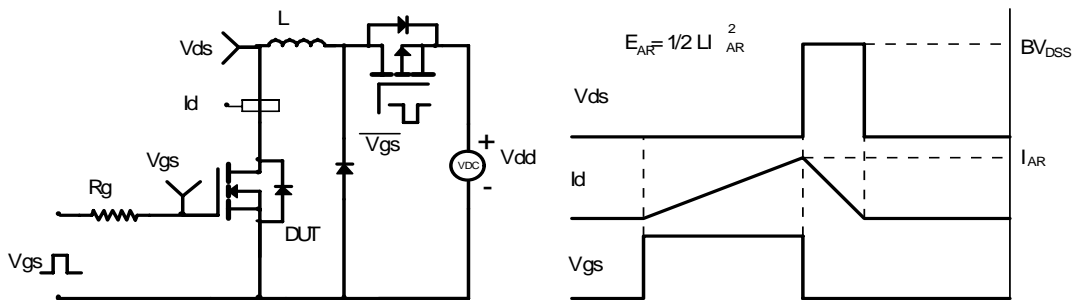

Diode Recovery Test Circuit & Waveforms

